

H650

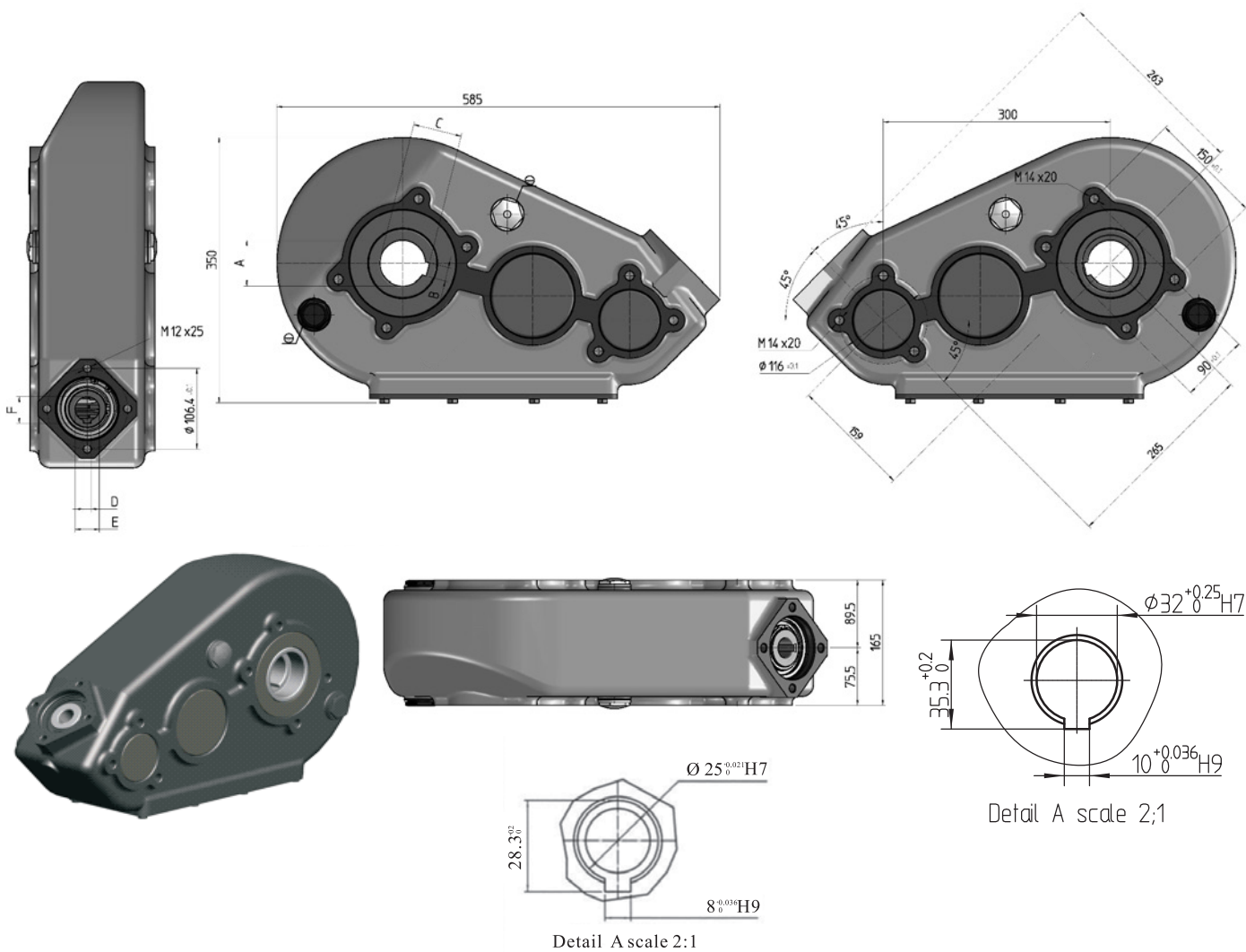

速比 Ratio	输出扭矩 Output torque N · m	重量 Weight Kg	润滑油 Lubrication	工作温度 Work temperature
37.8:1	6500	68	齿轮油 GEAR OIL CE80W90	-20° / +80°

A	B	C
Ø55	16	59.3
Ø60	18	64.4
Ø65	18	69.4